

**INDEPENDENT SURVEILLANCE  
SECURITY INC.**

**STARTER KIT  
USER'S MANUAL ///**



## INTRODUCTION TO YOUR HOME MONITORING STARTER KIT ///

Thank you for your purchase of the Home Monitoring Starter Kit. The **XG1000 Controller**, a small dedicated computer, allows you to access and control cameras and other devices in your home, and make this information available to you wherever you are. You can access the XG1000 from any PC (must be running Windows XP or 2000) with an internet connection anywhere in the world. You can even use the XG1000 from your cell phone. You only need to use a PC to set up your XG1000. From then on, no PC is required for the XG1000 to function.

The system uses IP cameras. These are devices that communicate through normal internet cabling. If you do not wish to run new Ethernet wiring in your home, you can use Power Line Communication modules (PLC's) to use the existing power outlets in your home, instead. Two of these modules are included in the starter kit.

In addition to the cameras, you can also use sensor modules in your home to monitor temperature, detect a door or window opening, wet conditions and motion. These are battery powered devices that communicate wirelessly with the controller. You can even turn lights and appliances on and off, by purchasing optional power controllers.

### WITH YOUR HOME MONITORING ACCOUNT YOU CAN:

- View Live Video
- Check Device Status
- Arm and Disarm Devices
- Set Up Rules to Perform Actions Based on Events or Time of Day
- Record Snapshots and Video Clips
- Review Archived Events

If you have a JAVA enabled cell phone, you can access most of the controller functions remotely through the phone. You need to download an application to your phone to do this. Other cell phones can receive text notifications, but cannot view live video or control devices.

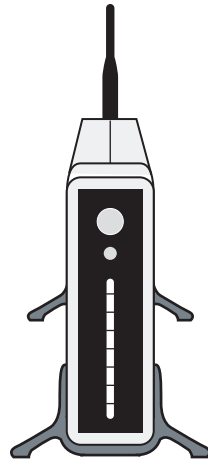

## FIRST TIME SETUP ///

### PREPARATION:

#### YOUR STARTER KIT CONTAINS THE FOLLOWING ITEMS:

- XG1000 Controller [X1] with AC Power Supply [A1] and Ethernet Cable [E1]
- IPC-1000 IP Camera [C1] with AC Power Supply [A2]
- 2 HomePlug Turbo 85Mbps PLC Ethernet Adapters [H1 & H2] and 2 Ethernet Cables [E2 & E3]
- Door Window Contact Sensor [D1] with Batteries [B1]
- Controller Mounting Hardware - 2 Feet [F1] & 2 Wall Brackets [G1]
- Documentation



XG1000  
CONTROLLER  
[X1]



IPC-1000  
IP CAMERA  
[C1]

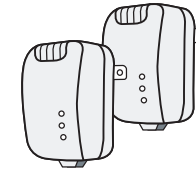

2 HOMEPLUG TURBO 85MBPS  
PLC ETHERNET ADAPTERS  
[H1 & H2]



DOOR/WINDOW  
CONTACT SENSOR  
[D1]

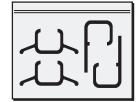

MOUNTING  
FEET/BRACKETS  
[F1 & G1]

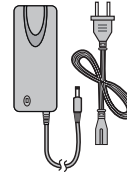

XG1000 AC  
POWER SUPPLY  
[A1]

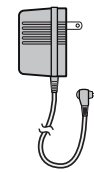

IPC-1000 AC  
POWER SUPPLY  
[A2]

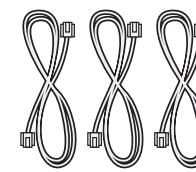

3 ETHERNET  
CABLES  
[E1, E2 & E3]



CONTACT SENSOR  
BATTERIES  
[B1]

Please check the contents of your starter kit prior to starting installation. **In addition to the items supplied in the kit you will also need a DSL/Cable Modem or other high speed internet connection, a router - or home network device - with at least two unused ports, and a Windows XP or 2000 PC** to set up the XG1000 Controller.

**The PC you will be using to install the system needs to be on the same router or local network as the XG1000 Controller.** After the installation, you can access the system from any PC connected to the Internet.

Your Internet connection and router should be functional before proceeding with this installation. As part of the purchase, you will have set up a Home Monitoring Account; you will need the UserID and Password that you created for this account later in the setup procedure.

## HARDWARE INSTALLATION:

### FOLLOW THE STEPS BELOW SET UP YOUR HOME MONITORING STARTER KIT:

1. Take the XG1000 Controller AC Power Supply [A1] from your Controller box. Plug the small end into the port marked Power on your XG1000 Controller [X1] and plug the other end into an AC electrical outlet.

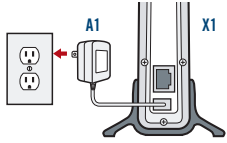

2. Connect supplied Ethernet Cable [E1] to the LAN Ethernet port of the XG1000 Controller [X1] and connect the other end to a free Ethernet port on your router.

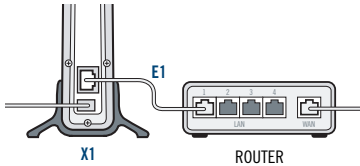

3. Connect one end of Ethernet Cable [E2] to the port on the bottom of the HomePlug Turbo PLC Ethernet Adapter [H1]. Connect the other end to a second free port on your router.

**NOTE:** You can connect a network hub or switch to any available Ethernet port on your router, if you need additional ports.

Plug the HomePlug Turbo PLC Ethernet Adapter [H1] into an AC electrical outlet.

For best results plug the HomePlug Turbo PLC Ethernet Adapter modules into a free AC wall outlet directly or, if not possible, into an AC power strip that has no other AC Power Supply plugged into it. The length of the power strip cord, or separate extension cord, should be no more than 5 feet and it should not be coiled.

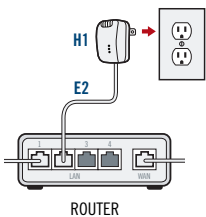

Once plugged into the AC electrical outlet, the LED's light up on the front of the HomePlug Turbo PLC Ethernet Adapter [H1] should light up. If the LED's do not light up on the front of the HomePlug Turbo PLC Ethernet Adapter [H1], please confirm that there is AC power coming to the outlet.

4. Bring your IPC-1000 IP Camera [C1], AC Power Supply [A2], HomePlug Turbo PLC Ethernet Adapter [H2], and Ethernet Cable [E3] to the location in your home that you wish to install your IPC-1000 IP Camera [C1].

Connect one end of the Ethernet Cable [E3] to the LAN port of the IPC-1000 IP Camera [C1] and connect the other end to the port on the bottom of the HomePlug Turbo PLC Ethernet Adapter [H2]. Plug the HomePlug Turbo PLC Ethernet Adapter [H2] into an AC electrical outlet.

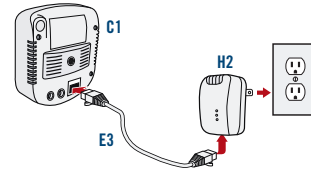

Plug the small end of the AC Power Supply [A2] into your IPC-1000 IP Camera [C1] AC Adapter port and the other end into an AC electrical outlet.

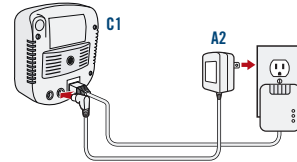

**NOTE:** If you prefer not to use the HomePlug Turbo PLC Ethernet Adapters, you may connect the IPC-1000 IP Camera directly to your router or other Ethernet port in your home instead.

An example of the completed configuration can be found below.

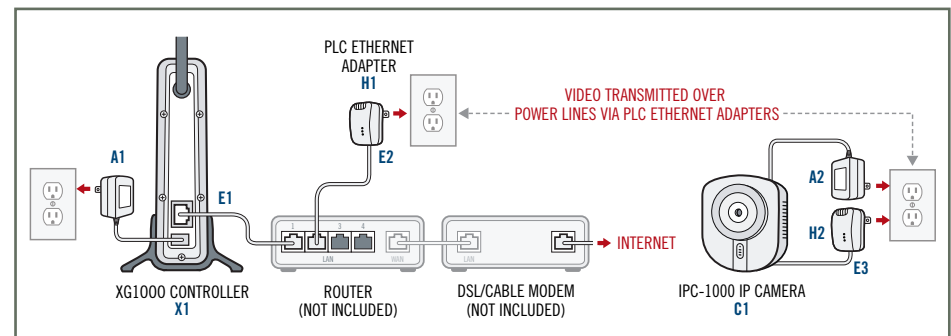

COMPLETED CONFIGURATION

## CONTROLLER REGISTRATION:

1. When you purchased your Home Monitoring system, you created a remote account with a **UserID** and **Password**. Using a web browser on a PC connected to the same local network as your XG1000 Controller, go to site <http://xanboo.com/iss> and log in using this ID and password.



2. After successfully logging in, select the **Account Settings** tab and then select **Discovery**.

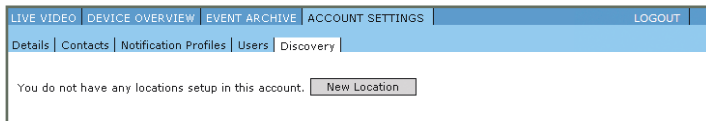

### CONTROLLER REGISTRATION

3. To register your controller with the remote service site, press the **'NEW LOCATION'** button. A plug-in will be downloaded from <http://xanboo.com/iss> that enables the browser to detect and communicate with the controller. A pop-up will be shown that will guide you through the process. If the software detects any problems with downloading or running the plug-in, an error message will be displayed that will link to help information. The most common cause for problems is security settings in the web browser that do not allow the required operations.

4. When the controller registration has completed, you will see a confirmation message as in the following picture. After you successfully register your controller you may be prompted to follow instructions in order to improve performance

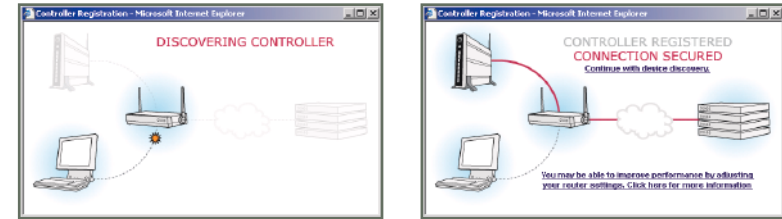

5. After the controller has been successfully installed and registered, it will automatically start device discovery. If you don't see a message that discovery is initializing or in progress, press the **'START DISCOVERY'** button. Any cameras that are detected will be registered automatically. Any other wireless devices need to be registered one at a time. You can do this now or you can register the additional devices later. To do this, examine the documentation that came with the device and locate the discovery button on the device. It is usually in a small hole in the case. Wait until one device is finished registering before you press the discovery button on the next device. When you are done, press the **'STOP DISCOVERY'** button.
6. Select the **Device Overview** tab and verify that all of your devices are shown.

## DEVICE DISCOVERY ///

### YOU CAN ADD DEVICES ANY TIME BY USING THE FOLLOWING PROCEDURE:

1. Select the **Account Settings** tab and then select **Discovery**.
2. Press the **'START DISCOVERY'** button and wait until you get a message indicating discovery is in progress.
3. Cameras should be detected and registered automatically. If you receive a message that the camera needs to be reset, press the **Factory Defaults** button on the camera.
4. For wireless devices, press the **Discover** button on each device, one at a time and wait until the device is registered before proceeding to the next one.
5. When you are finished adding devices, press the **'STOP DISCOVERY'** button. Go to the **Device Overview** page and make sure that all of the devices appear in the list

### YOU CAN ALSO DELETE DEVICES AT ANY TIME:

1. Select the **Account Settings** tab and then select **Discovery**.
2. Press the **'DELETE'** button next to the device that you would like to remove.
3. Confirm that you want the device to be deleted.
4. Go to the **Device Overview** tab and confirm that the device no longer appears in the device list.

## USING THE SYSTEM WITH A CORPORATE FIREWALL ///

If you are using the Home Monitoring system in an environment that is protected by a corporate firewall, you may need to make some settings that will allow you to get the best performance out of your system. The great majority of users will not need to use these settings.

Select **Account Settings** and then **Details**. In the section labeled **'HTTP PROXY'** there are fields for proxy **UserID** and **Password**. These settings will enable the live video window to use the most efficient method to get data from your camera. If you do not know what to enter in these fields, you need to ask your System Administrator.

## TIME ZONES ///

You must set the time zone in your controller so that events are time stamped with the correct information. This will also ensure that events you have set up to occur at certain times will perform as expected.

Because you can access the system from anywhere, there is the possibility that the controller is in a different time zone than where the remote viewing PC or cell phone is located. The default time zone for the controller is United States EST. If you need to change this, select the **Device Overview** tab. In the bar where the controller name is shown, click on the icon next to the controller name. You will be shown a pop-up where you can set various controller settings. Select a time zone and click **'Apply'**. The controller will be reset after this change, which may take a minute or so.

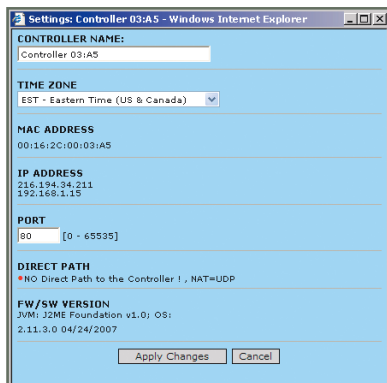

CONTROLLER SETUP POP UP WINDOW

## YOUR HOME MONITORING ACCOUNT! ///

Your account is set up into 4 sections: **Live Video**, **Device Overview**, **Event Archive** and **Account Settings**. Each section has a specific role, and understanding each role will allow you to maximize the Home Monitoring experience.

## LIVE VIDEO ///

For each discovered camera you will see a **Snapshot** of the view associated with the camera when you click on the **'LIVE VIDEO'** tab. This snapshot image is for identifying the camera; it is not updated in real time. The snapshot view for each camera can be refreshed by clicking the **'REFRESH'** button in the upper right corner of the image. Click on a camera snapshot to view live video from that camera.

### FROM THE LIVE VIDEO PAGE YOU WILL BE ABLE TO:

- Take a Snapshot of the Current Camera
- Start or Stop a Live Video
- Arm the Motion Sensor
- Toggle Between Cameras
- Record a Video Clip

The first time you access your Live Video you may be prompted with a pop-up window like the one below, to install a **JAVA** plug-in (if you're using Netscape or Firefox) or **ActiveX** plug-in (if you're using Internet Explorer). This plug-in is necessary to view your Live Video. The appearance of the plug-in installer will differ for the two plug-ins, but in both cases you must click **'YES'** to accept the download for the plug-in. Follow the instructions provided in the **INSTALLATION WIZARD** for the plug-in. The plug-in will take a few minutes to install.

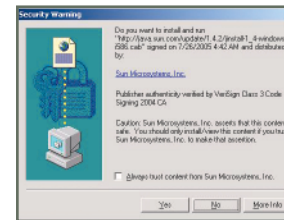

JAVA INSTALL POP UP WINDOW

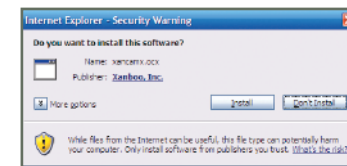

ACTIVE X INSTALL POP UP WINDOW

If you're using Netscape or Firefox, you will also be prompted by a security warning, like the one displayed below, when you access your Live Video. Answering **'ALWAYS'** will prevent this pop-up from being displayed again.

Selecting **'YES'** will disable the pop up for only that log-in session.

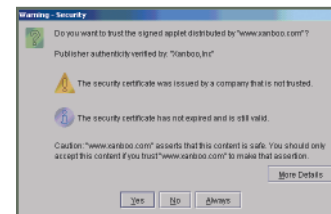

SECURITY WARNING POP UP WINDOW

## OPTIMIZING YOUR VIDEO PERFORMANCE:

To ensure that your video performance is optimized you can port forward your router. To do so, please repeat the controller registration process (refer to the instructions, steps 1-4, found on pages 5 and 6 of this manual) where you will be prompted with instructions on port forwarding.

You will be notified during controller registration if your video performance has already been optimized.





## USING THE FEATURES IN THE LIVE VIDEO WINDOW:



LIVE VIDEO WINDOW

The **Live Video** pop-up displays Live Video image along with buttons that will allow you to start  or stop  the camera.

You can manually take a snapshot or record a video by clicking the snapshot  and video  icons, respectively. Once a **Video Clip** or **Snapshot** is taken, they are stored in the **Event Archives** section of your account.

Each camera has a built-in motion sensor. You can set your camera's motion sensor to detect motion by using the **Arm Motion Sensor** checkbox seen below.



You can switch between cameras using the **Camera Selection** drop-down menu.

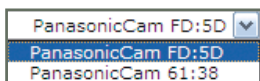

## XG1000 CONTROLLER ///

### INDICATORS:

There are ten indicators on the front of the controller.

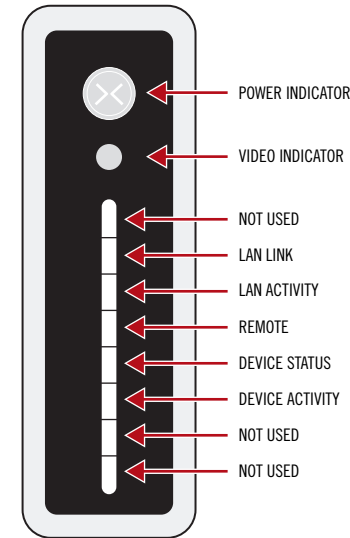

XG1000 CONTROLLER FRONT PANEL

### FROM TOP TO BOTTOM, THE FUNCTIONS ARE:

- **Power Indicator:** Will light up **Blue** when power is applied.
- **Video indicator:** Shows when one or more cameras are in use by flashing **Green**.
- Not Used
- **LAN Link:** Shows proper Ethernet connection between the controller and the router with a solid **Green**
- **LAN Activity:** Shows network activity between the controller and other devices by flashing **Green**
- **Remote:** Shows the status of the remote service connection
  - **Green** indicates good communication with the remote site
  - **Amber** indicates that the controller has not been registered with the remote site, yet.
  - **Red** indicates no communication between the controller and the remote site.
- **Device Status:** Shows the worst case status of the devices on the "Monitor" page. If all devices are **Green** then this LED will show **Green**. If one or more devices are **Yellow** or **Red**, the LED will light accordingly.
- **Device Activity:** Flashes **Green** to show when the controller is communicating with one of the wireless devices.
- Not Used
- Not Used

## BOOT SEQUENCE

When the controller is first powered up, the bottom five LED's on the front panel go through a boot-up sequence. The lights start out as **Red**, go to **Amber** and then **Green**. The process takes about three minutes.

## REAR PANEL:

The rear panel of the controller contains the ports for cable connections. The bottom round port is for the power. The AC adapter is plugged into this port. The other port is for the network cable. A standard Ethernet cable is connected between this port and your router.

The antenna on the back panel is used for communication between the controller and the wireless devices. It should normally be placed in an upright position. If you are having communication problems with sensors (as indicated on the ["Monitor" page](#)) you should try repositioning the antenna slightly.

If you are unable to access the controller, you may need to reboot the unit. There is a recessed button on the back labeled **'REBOOT'**. This button will reboot the controller while retaining all of the internal settings. You can use the white reset tool that comes with each sensor device to activate this button. The system will go through the normal boot sequence.

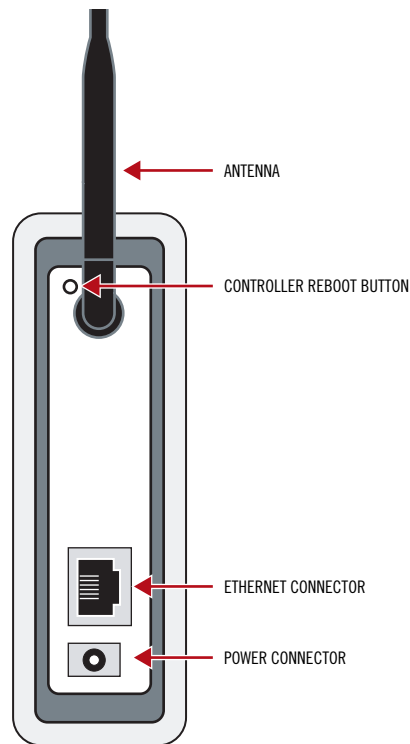

XG1000 CONTROLLER REAR PANEL

## MOBILE OPTION:

If you have a JAVA enabled cell phone you can access the system from just about anywhere. Just use your phone's web browser to download and install the application from <https://homesight.xanboo.com/j2me/> and enter your **Home Monitoring User ID** and **Password** when prompted. Data rates will apply, so you may want to consider subscribing to a data package.

